

# Electrically Release Brakes ERD and ERDD

Service Manual

P-2062-WE  
SM300gb - rev 11/04



 **Warner**<sup>®</sup>  
Electric

An Altra Industrial Motion Company

We, **WARNER ELECTRIC EUROPE**, 7, rue Champfleu, B.P. 20095, F-49182 St Barthélemy d'Anjou Cedex declare that these brakes are made in our factory from St Barthélemy d'Anjou,

and hereafter designated : **ERD and ERDD**

are exclusively designed for incorporation into a machine and to be assembled with other equipments to create a machine. The operation of the product is submitted to the conformity of the complete equipment, following the provisions of the machinery directive 98/37/EC and if electric to the EMC directive 89/336 /EEC. The conformity of the electric units to the Low Voltage directive 72/23 is supported by the full respect of the following standards : NFC 79300 and VDE 05808/8.65.

Drawn up in St Barthélemy d'Anjou, July 2002  
E. PRAT, General Managing Director

## CONTENTS

1	Technical specifications	2	4.2	Adjusting the detector	4
2	Precautions and restrictions on use	2	5	Electrical connection	4
2.1	Restrictions on use	2	5.1	Important recommendations	4
2.2	Precautions and safety measures	3	5.2	Power supply	4
3	Installation	3	6	Options	5
3.1	Transport - storage	3	6.1	Torque adjustment	5
3.2	Handling	3	6.2	Detection kit	5
3.3	Installing	3	7	Appendices	6-7
4	Maintenance	4	7.1	Appendix 1 (ERD 500 to 1600 and ERDD 1000 to 3200)	6
4.1	Adjusting the airgap	4	7.2	Appendix 2 (ERD 3200 to 12800 and ERDD 6400 to 25600)	7

### 1 Technical specifications (VAR00 and VAR03)

ERD Size		500	800	1600	3200	6400	12800
Nominal airgap	mm	0,4	0,6	0,6	1	1,3	1,5
Airgap tolerance	mm	± 0,005	+0,05/-0,1	+0,05/-0,1	±0,1	±0,15	±0,15
Pull-in airgap max.	mm	1	1,5	1,5	2	2,5	3
Tightening torque screw 909	Nm	48(±10%)	48(±10%)	110(±10%)	150(±10%)	260(±10%)	380(±10%)
Number of screws (Rep. 903)	-	2xM10x80	4xM12x90	3xM16x110	8xM20x120	8xM20x140	8xM20x180
Handling Screws	-	M8	M12	M12	M16	M16	M20
Allowable wear max*	mm	4	4	6,5	9	10	14,7

ERDD Size		1000	1600	3200	6400	12800	25600
Nominal airgap	mm	0,5	0,7	0,7	1,3	1,7	1,9
Airgap tolerance	mm	± 0,05	+0,05/-0,1	+0,05/-0,1	±0,1	±0,15	±0,15
Pull-in airgap max.	mm	1	1,5	1,5	2	2,5	3
Tightening torque screw 909	Nm	48(±10%)	48(±10%)	110(±10%)	150(±10%)	260(±10%)	380(±10%)
Number of screws (Rep. 903)	-	2xM10x80	4xM12x90	3xM16x110	8xM20x120	8xM20x140	8xM20x180
Handling Screws	-	M8	M12	M12	M16	M16	M20
Allowable wear max*	mm	9	10,5	13,5	16,5	15	15,5

\*See paragraphs 4-2 and 4-3

Table 1

### 2 Precautions and restrictions on use



Symbol designating an action that might damage the brake



Symbol designating an action that might be dangerous to human safety



Symbol designating an electrical action that might be dangerous to human safety

#### 2.1 Restrictions on use



These units are designed for dry operation. The brake must be free from oil and grease.



ERD 500, ERD 800 and ERD 1600 can be horizontally or vertically mounted, all other units can only be mounted horizontally.





Exceeding the maximum rotation speed listed in the catalogue will invalidate the guarantee.



Ambient temperature for these units is max 40° C (insulation class of 155°C).

## 2.2 Precautions and safety measures





-  During the maintenance period make sure that the moving parts of the machine are stationary and that there is no risk of start-up. All intervention have to be made by qualified personnel, owning this manual.
-  It is imperative that the release screws (903) are mounted before any operation is made to the unit.
-  Any modification made to the brake without the express authorisation of a representative of Warner Electric, in the same way than any use out of the contractual specifications accepted by "Warner Electric", will result in the warranty being invalidated and Warner Electric will no longer be liable in any way with regard to conformity.

## 3 Installation

### 3.1 Transport / storage

These units are delivered in packaging that guarantees a 6 months storage period whether transported by land, by air, or by sea to any destination excepting tropical countries. (For tropical destinations please consult Warner Electric technical services).

### 3.2 Handling

-  The unit is supplied pre-assembled except for the hub.
-  Do not expose the unit to shocks whilst handling as this may reduce performance.
-  Use the handling holes provided for any operation (See Fig. 1, table 1).
-  Never transport the unit by the cable.

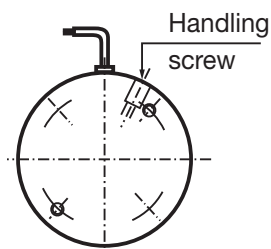



Fig. 1



### 3.2 Installation

-  To mount the unit proceed as follows: according to types, (see appendices 1 or 2):

Compress springs with release screws (903). The moving armature (330) must be pulled against the inductor (101).

Loosen the locking screws (909), the friction plate (348), the friction disc(s) (312) and the intermediate disc (320) or (321) for brakes with dual discs.

Slide the hub (515) onto the shaft to be braked, fit the driving key and secure it axially.

-  Keep the driving splines free of oil (i.e. friction disc / hub). Otherwise this may reduce performance.
-  It is important to note the hub mounting directions (See Fig. 2).

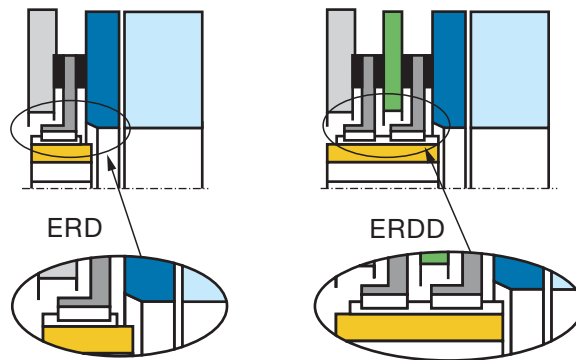

Fig. 2

The hub is normally supplied with the following norms : tolerances H7 for bore, P9 for keyways (According to NF E 22-175/DIN 6885/BS 4235/ISO R773).

Fit the friction plate (348) onto the mounting surface. For single disc brakes from size 3200 and for dual disc brakes from size 6400, the friction plate is directly fixed on the mount with CHC screws (not provided) and secure them with a LOCTITE 270 product.

Now install the friction disc (312). If this is a dual disc brake, then fit the intermediate disc (320) or (321) and finally install the second friction disc (according to size).

**NOTE:** The angle of the friction discs must be facing the friction plate (see Fig. 2).

Slide the pre-camped moving armature (330) / inductor (101) between the friction faces and fix it with locking screws (909) and washers noting carefully the tightening torque (see table 1 page 2).

Remove release screws (903). Energize the unit (see chapter 5) and check if the friction disc rotates freely.

Energise the brake a number of times whilst the motor is static and check the nominal airgap value (See table 1 page 2) near the faces of the friction plate (348). If insufficient airgap, see chapter 4 (maintenance)

## 4 Maintenance

### 4.1 Airgap setting

To adjust the airgap (see appendix 1 or 2), loosen the locking screws (909), then turn the adjusting screws (902) adjusting to the airgap required. Tighten the locking screws (909) to the required torque (see table 1).

Check the airgap value again at various points near the faces of the friction plate.

Energise the brake a number of times whilst the motor is static, re-check the airgap value at the various points.

### 4.2 Maintenance

Friction material wear generates an increase in the airgap value. To reach the maximum airgap (see table 1), it is necessary to set it (see Chapter 4.1).

### 4.3 Spare parts

 After continued operation varying according to unit size and use, it may become necessary to replace one or more friction discs when the minimum value Y is reached (see Fig. 3 and table 2).

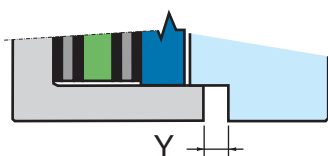

Fig. 3

ERD	500	800	1600	3200	6400	12800
Y min (mm)	2	2	2	3	4,5	3
ERDD	1000	1600	3200	6400	12800	25600
Y min (mm)	3	3	3,5	3,5	3	3

Table 2

To proceed see chapter 3-3. Re-adjustment of the airgap is necessary (see chapter 4.1).

## 5 Electrical connection

The brakes ERD & ERDD must be supplied with D.C voltage and are fitted with a 500 mm length cable. Polarity does not affect the functioning.

### 5.1 Important recommendations

 All works on the electrical connections have to be made with power off.

 Note carefully the nominal supply voltage (low supply voltage generates low pull-in distance).

Electric leads must be large enough to prevent voltage drops between power supply and the unit.

I (A) / L (m)	0 to 10 m	von 10 to 20 m
0 to 3 (A)	1,5 mm <sup>2</sup>	1,5 mm <sup>2</sup>
3 to 6 (A)	1,5 mm <sup>2</sup>	2,5 mm <sup>2</sup>

Supply voltage tolerances on the brake : +5% / -10% (NF C 79-300)

### 5.2 Power supply

We recommend the use of Warner Electric power supply CBC 140-5 (with over-excitation and handling voltage).

The switch on/switch off process has a major effect on the response time. Response times listed in the catalogue refers to nominal supply voltage with switching on DC side.

If switching on the AC side, the response time in braking can be multiplied by 6.

- If over-excitation occurs during drop-out, the pull-in distance can be divided by 3 (depending on net voltage).
- When the operating voltage falls to 50% of the nominal value it reduces braking response time and working temperature.

**Warner Electric** power supplies are designed to protect the coils and circuitry. If the brake is used power off with switching on DC side, it is essential to protect the coil with a varistor mounted in parallel.

## 6 Options

### 6.1 Torque adjustment

Only possible with VAR03. The brakes are delivered adjusted with nominal torque value.

#### Principle of torque reduction

(See table 3 and Fig. 4). Unscrew the adjusting cap located behind the inductor without exceeding the dimension M min.

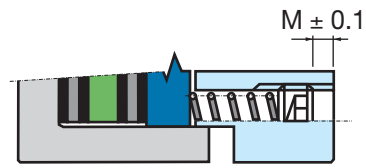

Fig. 4

Table 3 (for VAR03 only)

ERD Sizes		500	800	1600	3200	640-0	12800*
Nominal Torque	Nm	500	800	1600	3200	6400	12800
Dimension M (±0,1mm)	mm	13,7	17,1	27,3	14,5	-	-
Torque min.	Nm	360	580	1180	2550	-	-
Dimension M min. (±0,1mm)	mm	0	5,1	15,3	5,5	-	-
Theoretic reduction of nom. torque for 1 round of adjusting cap	%	4	4	5	6	-	-

ERDD Sizes		1000	1600	3200	6400	12800*	25600*
Nominal Torque	Nm	1000	1600	3200	6400	12800	25600
Dimension M (±0,1mm)	mm	13,7	17,1	27,3	14,5	-	-
Torque min.	Nm	700	1200	2350	5600	-	-
Dimension M min. (±0,1mm)	mm	0	5,1	15,3	5,5	-	-
Theoretic reduction of nom. torque for 1 round of adjusting cap	%	4	4	5	6	-	-

\* **NOTE:** for ERD 6400 & 12800 and ERDD 12800 & 25600, the torque is reduced by removing the springs. This operation is carried out in our plants.

### 6.2 Detection kit

#### Mounting:

Check that the brake is correctly adjusted with nominal airgap. Fit the M6 screw in the moving armature and mount the nut (see Fig. 5), fit the sensor with the M3 screws and washers.

#### Adjustment

Insert a feeler gauge in gap X (see table 4) between the inductor and the moving armature. Switch the brake on, and adjust the screw until you obtain action on the sensor, then tighten the locking nut. Check the unit works correctly with successive pull-in and pull-outs.

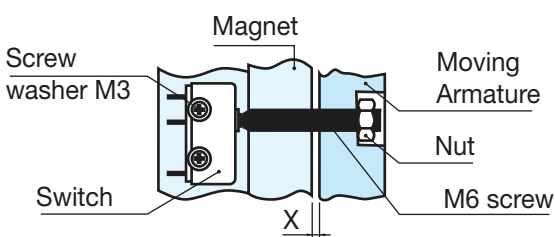

Fig. 5

Table 4

ERD	500	800	1600	3200	6400	12800
Dimension X (± 0,05 mm)	0,2	0,4	0,4	0,7	1	1
ERDD	1000	1600	3200	6400	12800	25600
Dimension X (± 0,05 mm)	0,2	0,4	0,4	0,7	1	1

#### Switch Data

Protection Class IP 65  
 Temperature -40°C / +120°C  
 Cable 3 x 0,75 mm  
 Switching 8A - 250 VAC / 6A - 380 VAC

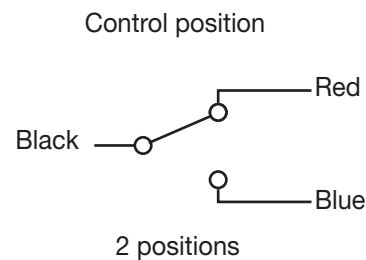

7 Appendices

7.1 Appendix 1

Rep.	Designation
101	Magnet
312	Friction disc
320	Intermediate disc
330	Moving armature
348	Friction plate
515	Hub
740	Spring
902	Adjusting screw
903	Release screw
909	Locking screw
917	Transport nut
921	Washer
935	Adjust cap

ERD 500 to 1600

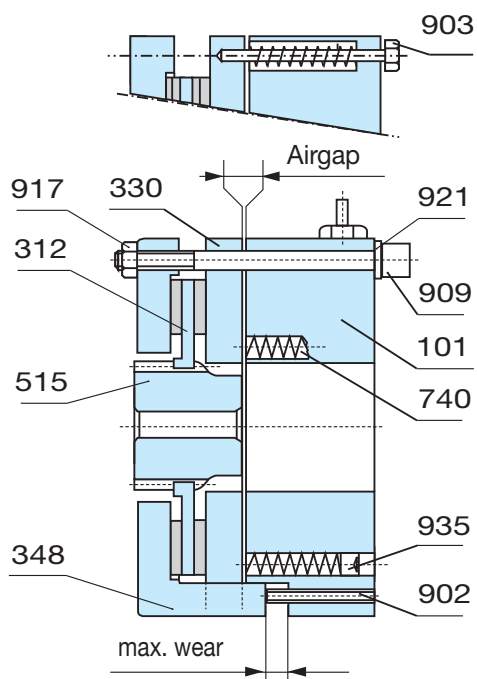

ERDD 1000 to 3200

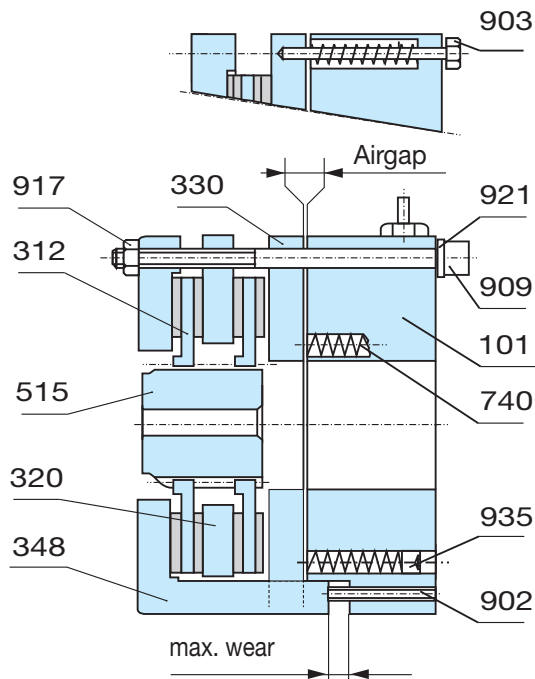

## 7.2 Appendix 2

Rep.	Designation
101	Magnet
312	Friction disc
321	Furnished intermediate disc
322	Mounted friction lining
330	Moving armature
348	Friction disc
515	Hub
740	Spring
902	Adjusting screw
903	Release screw
909	Locking screw
921	Washer
935	Adjust cap
960	Push

**ERD 3200 to 12800**

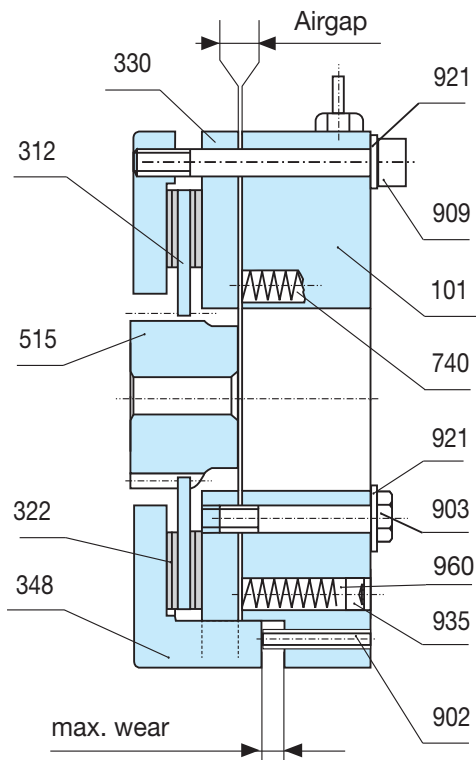

**ERDD 6400 to 25600**

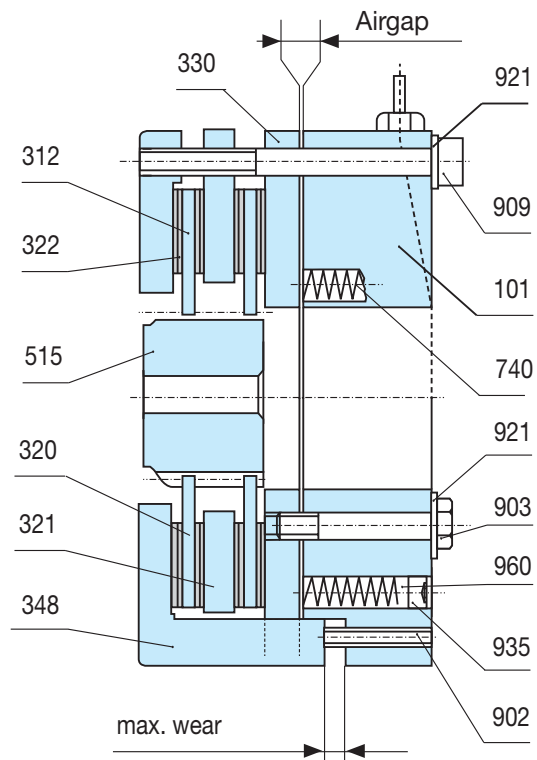

# Warranty

Warner Electric LLC warrants that it will repair or replace (whichever it deems advisable) any product manufactured and sold by it which proves to be defective in material or workmanship within a period of one (1) year from the date of original purchase for consumer, commercial or industrial use.

This warranty extends only to the original purchaser and is not transferable or assignable without Warner Electric LLC's prior consent.

Warranty service can be obtained in the U.S.A. by returning any defective product, transportation charges prepaid, to the appropriate Warner Electric LLC factory. Additional warranty information may be obtained by writing the Customer Satisfaction Department, Warner Electric LLC, 449 Gardner Street, South Beloit, Illinois 61080, or by calling 815-389-3771.

A purchase receipt or other proof of original purchase will be required before warranty service is rendered. If found defective under the terms of this warranty, repair or replacement will be made, without charge, together with a refund for transportation costs. If found not to be defective, you will be notified and, with your consent, the item will be repaired or replaced and returned to you at your expense.

This warranty covers normal use and does not cover damage or defect which results from alteration, accident, neglect, or improper installation, operation, or maintenance.

Some states do not allow limitation on how long an implied warranty lasts, so the above limitation may not apply to you.

Warner Electric LLC's obligation under this warranty is limited to the repair or replacement of the defective product and in no event shall Warner Electric LLC be liable for consequential, indirect, or incidental damages of any kind incurred by reason of the manufacture, sale or use of any defective product. Warner Electric LLC neither assumes nor authorizes any other person to give any other warranty or to assume any other obligation or liability on its behalf.

WITH RESPECT TO CONSUMER USE OF THE PRODUCT, ANY IMPLIED WARRANTIES WHICH THE CONSUMER MAY HAVE ARE LIMITED IN DURATION TO ONE YEAR FROM THE DATE OF ORIGINAL CONSUMER PURCHASE. WITH RESPECT TO COMMERCIAL AND INDUSTRIAL USES OF THE PRODUCT, THE FOREGOING WARRANTY IS IN LIEU OF AND EXCLUDES ALL OTHER WARRANTIES, WHETHER EXPRESSED OR IMPLIED BY OPERATION OF LAW OR OTHERWISE, INCLUDING, BUT NOT LIMITED TO, ANY IMPLIED WARRANTIES OF MERCHANTABILITY OR FITNESS.

Some states do not allow the exclusion or limitation of incidental or consequential damages, so the above limitation or exclusion may not apply to you. This warranty gives you specific legal rights and you may also have other rights which vary from state to state.

## Changes in Dimensions and Specifications

All dimensions and specifications shown in Warner Electric catalogs are subject to change without notice. Weights do not include weight of boxing for shipment. Certified prints will be furnished without charge on request to Warner Electric.



**Warner Electric Europe**  
7 rue Champfleu, B.P. 20095, St Barthelemy d'Anjou - France  
+33 (0)2 41 21 24 24 • Fax: +33 (0)2 41 21 24 70  
[www.warnerelectric.com](http://www.warnerelectric.com)